

Features:

- No UV or IR light radiation.
- Provide 120° beam angles.
- Low Power Consumption: Less than 20Watts.
- Long lifetime: 25000 hours (L₇₀).
- High CRI: 70-85.
- Operating temperature: -20°C~+60°C.
- 12-28V DC input.
- LED type:SHARP 2828/4PCS.
- Waterproof grade :IP65.
- Lamp type:T10.
- Corner light / width light.



Benefits:

- Energy Cost Savings:
Over 60% Compared to Incandescent.
- Solid-State:
High-Shock & High-Vibration Resistant,
Both Electrical and Mechanical
- Energy Cost Savings:
- Eco-Friendly:
No Mercury, No Lead Content
- No Hazardous Emissions:
No UV or IR Radiation
- Constant Light Output:
Even Lighting, Non-Halation

Applications:

- Used in automobile lights: Corner light / width light
- Other Lighting

Product Specifications:

Input Voltage	12-28V DC
Wattage	20W
Operating Temperature	-20°C ~ +60°C
Storage Temperature	-30°C ~ +70°C
Net Weight per piece (g)	3g
Certifications	RoHS Compliant
Size	∅ 11.2*29mm

Product Selection Guide:

Part No.	Beam Angle	Total Lumens	CCT/wavelength	Color	CRI
AL-W20WU-T10	360°	150±10%	5500-6500K	White	≥70

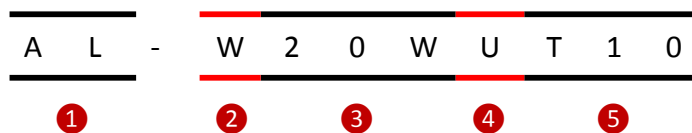

①	AL:	Automotive Light
②	W:	W-White
③	20W:	The LED Power is 20W
④	U:	DC12-28V
⑤	T10:	Type

Product Dimensions:

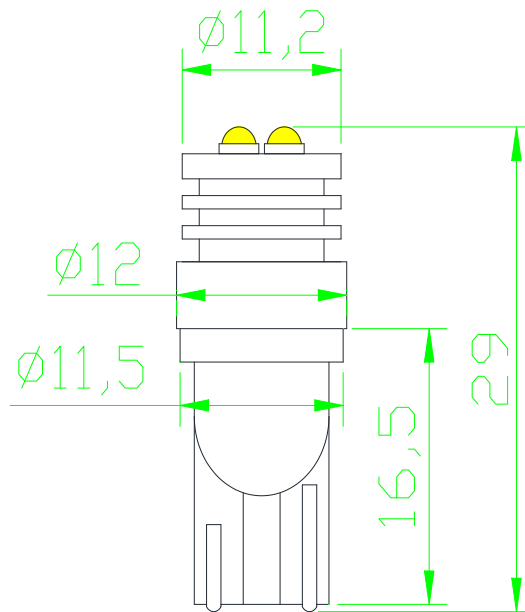

Notes:

1. All dimensions unit in mm
2. Tolerances are ± 1 mm unless otherwise noted.

Package Dimension:

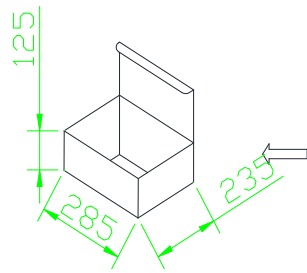

Small carton
285L*235W*125Hmm
(11.22"L*9.21"W*4.92"H)
100pcs Automotive light inside

Installation Instructions and Warnings:

- Turn off power before inspection, installation, or removal.
- Not for use where exposed to the weather
- Do not use in totally enclosed fixtures.
- Not for use with dimmers.
- Please make sure to use a suitable adapter. Please mind the minimum load of your adapter.

Notes:

The part number, type, and specifications mentioned in this document are subject to future change and improvement without notice. Before production usage customer should refer to the latest datasheet for the updated specifications.